

Article number: 204060M1280A3S

Description: E+G levelling foot

GN 40-60-M12-80-A3-S

Note: S Without nut, External hexagon at the bottom

Measures

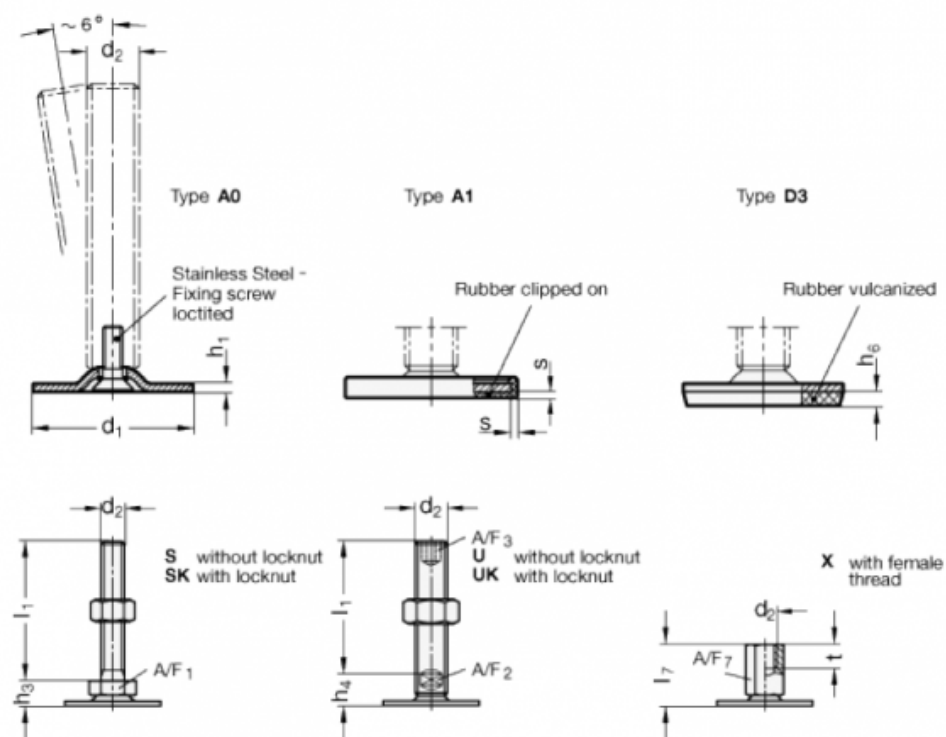

A/F1	= 17
d1	= 60
d2	= M12
h1	= 2.5
h3	= 11
h6	= 4.5
l1	= 80
s	=